

Understanding the movement predictability of international travelers using a nationwide mobile phone dataset collected in South Korea

Yang Xu^{a,b,*}, Dan Zou^{a,d}, Sangwon Park^c, Qiuping Li^d, Suhong Zhou^d, Xinyu Li^a

^a Department of Land Surveying and Geo-Informatics, The Hong Kong Polytechnic University, Hong Kong, China

^b The Hong Kong Polytechnic University Shenzhen Research Institute, Shenzhen, China

^c Smart Tourism Education Platform, College of Hotel & Tourism Management, Kyung Hee University, Republic of Korea

^d School of Geography and Planning, Sun Yat-sen University, China

ARTICLE INFO

Keywords:

Location prediction

Mobile phone data

Deep learning

Human mobility

Tourist mobility

Smart tourism

ABSTRACT

The abilities to predict tourist movements are critical to many urban applications, such as travel recommendations, targeted advertising, and infrastructure planning. Despite its importance, our understanding on the movement predictability of urban tourists and visitors is still limited, partially due to difficulties in accessing large scale mobility observations. In this study, we aim to bridge this gap by analyzing a nationwide mobile phone dataset. The dataset captures movement traces of a large number of international travelers who visited South Korea in 2018. By introducing two prediction models, one being Markov chain and the other with a recurrent neural network architecture, we assess how well travelers' movements can be predicted under different model settings, and examine how predictability relates to travelers' length of stay and activeness in travel patterns. Since travelers' destination choices are quite diverse in South Korea, this enables us to further investigate the geographic variation of the models' performance. Results show that the Markov chain model achieves an overall accuracy between 33.4% (@Acc1 metric) and 64.2% (@Acc5 metric), compared to 41.9% (@Acc1) and 67.7% (@Acc5) for the recurrent neural network model. The prediction capabilities of both models are largely unequal across individuals, with active travelers being more predictable in general. There is a notable geographic variation in the models' performance, meaning that travelers' movements are more predictable in some cities, but less in others. We believe this study represents a new effort in portraying the movement predictability of urban tourists and visitors. The analytical framework can be applied to assist tourism planning and service deployment in cities.

1. Introduction

Understanding the predictability of human mobility is an important research topic in urban studies. The abilities to predict human movements are critical to many applications, such as travel recommendations, targeted advertising, and transportation planning. In the past two decades, our understanding of human mobility has been greatly enhanced, largely due to the increasing availability of human movement datasets. These novel mobility observations, such as GPS tracking (Li et al., 2008; Solomon, Livne, Katz, Shapira, & Rokach, 2021), geolocated social media (Cho, Myers, & Leskovec, 2011; Hawelka et al., 2014), and mobile phone data (Gonzalez, Hidalgo, & Barabási, 2008; Jiang, Ferreira, & González, 2017; Song, Qu, Blumm, & Barabási, 2010; Xu, Belyi, Bojic, & Ratti, 2018), have unveiled many factors that shape the

predictability and regularity of human movements. Despite these fruitful research outcomes, most of the findings are drawn upon urban residents. The mobility dynamics of other population groups, such as urban tourists and visitors, remain underexplored.

How tourists or visitors (broadly conceived as *travelers* in this paper) move around in a city or tourism destination can be understood through different means, such as surveys, GPS tracking technologies, and geotagged social media. Due to cost of recruiting participants and other challenges, many studies can only study a small traveler population, such as a few hundred people, through the usage of travel surveys (Lau & McKercher, 2006; Xiao-Ting & Bi-Hu, 2012) or GPS tracking (Orellana, Bregt, Ligtenberg, & Wachowicz, 2012; Pettersson & Zillinger, 2011). This makes it difficult to generalize findings to the large populations. Social media data, such as geotagged photos (Lu, Wang, Yang, Pang, &

* Corresponding author at: Department of Land Surveying and Geo-Informatics, The Hong Kong Polytechnic University, Hong Kong.

E-mail address: yang.ls.xu@polyu.edu.hk (Y. Xu).

<https://doi.org/10.1016/j.compenurbysys.2021.101753>

Received 3 June 2021; Received in revised form 23 December 2021; Accepted 23 December 2021

Available online 6 January 2022

0198-9715/© 2021 Elsevier Ltd. All rights reserved.

Zhang, 2010) and check-ins (Zhang & Zhou, 2018), could capture movements of large numbers of travelers. However, user observations can be sparse as location recordings are passively generated when travelers posted photos or checked in at a place. In other words, movement trajectories are often incomplete, therefore cannot portray a comprehensive picture of travel behavior.

The ways travelers move around differ notably from residents. Previous studies have suggested that residents exhibit a notable level of movement predictability, largely due to the regularity in their travel patterns (Gonzalez et al., 2008). Many studies are able to track residents over a prolonged period of time (e.g., a few months or years). Some of them would apply entropy-based measures to quantify mobility regularity as a way to reflect movement predictability (Goulet-Langlois, Koutsopoulos, Zhao, & Zhao, 2017; Song et al., 2010). However, travelers (e.g., tourists) usually stay at a destination for a few days, or a couple weeks at most (McKercher, Shoval, Ng, & Birenboim, 2012; Raun, Ahas, & Tiru, 2016; Xu, Li, Belyi, & Park, 2021). This makes entropy-based measures inadequate as their observations are temporary. Therefore, a common approach is to apply prediction models and assess their abilities to predict travelers' movements. However, such studies are still scarce, and knowledge has been obtained in few cities (Sun, Huang, Peng, Chen, & Liu, 2019; Xia, Zeepongsekul, & Packer, 2011) or confined geographic areas such as parks (Zheng, Huang, & Li, 2017). There is a limited understanding of movement predictability across cities and over large tourist populations.

The predictability of travelers' movements is also context dependent. For instance, Markov chain models have been widely used for next-location prediction (Gambis, Killijian, & del Prado Cortez, 2012; Xia, Zeepongsekul, & Arrowsmith, 2009). These models are based on movement transition probabilities among locations, thus favor collective behavioral choices. In this regard, travelers with "mainstream" movement patterns are likely to be more predictable given the usage of Markov chain. Yet, there may exist long-term dependencies in travelers' movements. For example, travelers with recurrent visits to some locations are more predictable in some sense. In other words, the predictability of travelers' movements is jointly shaped by individual and collective behavioral dynamics. Prediction models with different settings may yield different interpretations (e.g., Markov chain models vs. recurrent neural network models).

The abilities to predict travelers' movements are also affected by their length of stay (Rodriguez, Martinez-Roget, & Gonzalez-Murias, 2018), how frequently they move (Xu, Xue, Park, & Yue, 2021), usage of transportation services (Le-Klaehn & Hall, 2015), and other factors such as the presence of travel parties (Zhao, Lu, Liu, Lin, & An, 2018). It is meaningful to investigate how movement predictability varies with travelers' behavioral characteristics. Moreover, given possible variations of the above factors across space, it is possible that the abilities to predict travelers' movements would vary among cities. These aspects are understudied in existing research, partially due to difficulties in accessing large-scale mobility observations over these populations.

Recent years have witnessed an increasing usage of mobile phone data in understanding tourist travel behavior (Park, Xu, Jiang, Chen, & Huang, 2020; Raun et al., 2016; Saluveer et al., 2020; Xu, Li, Xue, Park, & Li, 2021; Zhao et al., 2018). These datasets are able to capture movement patterns of large populations at relatively fine spatio-temporal resolutions. Thus, to fill the above research gaps, this study analyzes a nationwide mobile phone dataset which captures the movement traces of 192,302 international travelers who visited South Korea in 2018. The dataset empowers us to seek a deeper understanding of travelers' movements and their predictability over a highly representative population. We first introduce a spatial clustering method to identify areas in South Korea that are of interest to these international travelers. By focusing on travelers whose activities mainly fall within these areas, we introduce two prediction models, one being Markov chain and the other with a recurrent neural network architecture, to assess how well their movements can be predicted. Through model

comparisons, we demonstrate how different model settings would yield varying levels of prediction performance as well as inter-personal variations. Following that, we evaluate how travelers' length of stay and activeness in travel patterns impact the models' prediction accuracy. Since travelers' destination choices are quite diverse in South Korea and many of them would visit multiple cities during their journeys, this empowers us to examine the predictability of travelers' movements when they were moving within a city (intra-city) or heading towards another (cross-city). Finally, by focusing on intra-city movements, we investigate how the models' prediction capabilities vary geographically. We believe this study is a pioneering effort in portraying the movement predictability of tourists and visitors within and across cities. We argue that structures of input data, configuration of prediction models, and geographic contexts of tourism destinations have a joint impact on how we interpret and predict travelers' movements. The research findings can be leveraged to inform tourism planning and service deployment in cities (e.g., location-based recommendations).

2. Study area and dataset

This study¹ uses a large scale mobile phone dataset collected in South Korea. The anonymized dataset tracks the location footprints of 192,302 international travelers who visited the country between August 1st and 15th, 2018. The dataset was acquired from a major cellular operator in South Korea as part of a tourism big data project with the Korea Tourism Organization.

Call Detail Records (CDRs) and Mobile Signaling Data (MSD) are two typical types of phone data used in mobility research (Gonzalez et al., 2008; Xu et al., 2015, 2020). These datasets document phone users' whereabouts as a sequence of locations captured at discrete time points. CDRs are passively generated during phone usage activities (e.g., phone call & text message), while MSD tracks user locations in a more continuous manner through different types of signaling events triggered by the telecommunication system (e.g., cellular handover, periodic location update). The dataset used in study is regarded as a special type of MSD, in which phone records are preprocessed by the data provider to generate estimates of dwell time at cell tower level. Table 1 shows an example of an individual's mobile phone trajectory. Each record tracks the unique ID of the user, date of observation, the cell tower location (lon/lat) where the user's mobile phone was observed, as well as the start and end time that define the stay period. There are a total number of 3.69 million records in this dataset.

To better understand the spatial granularity of the dataset, for each cell tower, we measure its distance to the nearest peer. By measuring this distance for all cell towers, we obtain a distribution with the 25th percentile, median, and 75th percentile being 139.7, 264.6 and 632.2 meters, respectively. In general, the dataset has an adequate spatio-temporal resolution to support the location prediction analysis.

For these 192,302 international travelers, their duration of stay in South Korea could vary substantially. Some of them could even be

Table 1
Example of an individual's mobile phone records in the dataset.

User id	Date	Start time	End time	Longitude	Latitude
123***	2018-08-01	12:11:00	13:43:00	126.***	37.***
123***	2018-08-01	13:51:00	14:31:00	127.***	37.***
123***	2018-08-01	14:44:00	15:12:00	127.***	37.***
...
123***	2018-08-03	15:34:00	15:50:00	129.***	35.***
123***	2018-08-03	16:39:00	23:50:00	129.***	37.***

¹ See a data visualization of this study: https://youtu.be/zkH6Xu2_8MA

transfer passengers who temporarily stayed in the country. To tackle this issue, we have filtered users who appeared in the dataset for less than 12 hours. This gives us 129,332 users as the base for the prediction task.

3. Methodology

3.1. Generate individual location sequence from mobile phone data

The initial step for the prediction task is to define the scale at which the analysis is performed. Although phone users' records were documented at the cell tower level, it is not appropriate to perform the prediction task using this spatial unit, primarily for two reasons. First, the positional accuracy of mobile phone data is affected by the densities of cell towers in space as well as issues of cellphone load balancing and signal strength variation (Isaacman et al., 2012). Therefore, cell towers might not reflect the exact locations of mobile phone users. Second, in areas where cell towers are densely distributed, each cell tower usually covers a small service area, therefore cannot represent activity locations that are meaningful to travelers (e.g., tourism attractions). Note that some studies used regular grid as the spatial unit for location prediction (Calabrese, Di Lorenzo, & Ratti, 2010; Yao, Zhang, Huang, & Bi, 2017). Adopting this approach will also introduce uncertainties. Since each cell tower covers a service area, which is sometimes approximated using Voronoi tessellation (Blondel, Decuyper, & Krings, 2015), mapping these coverage areas to grid cells is challenging because a Voronoi polygon could overlap with multiple grid cells, and vice versa. Tackling this issue would require more complicated methods such as probabilistic approaches.

To tackle the above issues, we first introduce a spatial clustering method to group cell towers in close proximity into clusters. The cell tower clusters are then used as the spatial unit for the prediction task. Note that a traveler's mobile phone trajectory at the cell tower level can be represented as $T = \{(l_1, t_1^s, t_1^e), (l_2, t_2^s, t_2^e), \dots, (l_N, t_N^s, t_N^e)\}$, where l_i denotes the cell tower location of the i^{th} record, and t_i^s and t_i^e denote the start and end time of the stay. The spatial clustering works as follows. By iterating trajectories of all travelers, we compute the total number of times each cell tower was visited and sort them in descending order. We locate the cell tower with the highest visitation frequency and group nearby towers within a roaming distance of Δd . Among cell towers that are not grouped, the one with the highest visitation frequency is then selected and grouped with towers within Δd . The clustering process terminates until all cell towers are processed.

In this study, we set Δd as 2km . There are two considerations for choosing this value. First, 2km is notably higher than the average spacing gap between cell towers in the study area. It would ensure that phone users' movements observed at this scale are not contaminated by particular uncertainty issues, such as "fake movements" between towers

that are caused by cellphone load balancing. Second, 2km is also a radius that can characterize many locations meaningful to travelers (e.g., a park, a hotel resort, a shopping mall). One might argue that 2km is too coarse to capture certain points of interest (POI) such as a restaurant or an antique store. Considering the limited positional accuracy of mobile phone data, this study does not examine travelers' mobility predictability at a finer spatial resolution.

As a result, the clustering method yields a total number of 6969 spatial clusters. By iterating all phone users' trajectories, we calculate the total number of times each cluster was visited as an indicator of its popularity. We find that the top 1151 cluster areas account for 95% of the total visits, meaning that the remaining clusters only attracted a tiny fraction of visits (Fig. 1A). Therefore, this study only focuses on the top 1151 cluster areas in the prediction task. The lowest visitation frequency of these clusters is 70. For each phone user's raw cellphone trajectory T , we further convert it into a location sequence observed at the level of the spatial clusters $T_c = \{l_1, l_2, \dots, l_M\}$, where l_n denotes the cluster area visited by the user at time step n , and M denotes the total length of the sequence. For simplicity, we refer to these location sequences as *user trajectories* in the remaining of the paper.

A location in T_c is labeled as "Others" if it falls within a cluster out of the top 1151. According to this definition, we find that 87% of the travelers only visited the top 1151 clusters during their stays in South Korea. Intuitively, these travelers are samples appropriate for the prediction tasks. Note that other travelers had part of their trips between highly and less visited clusters ("Others"). In this research, we further incorporate travelers who have at least 70% of their observations in the top 1151 clusters into our analysis (Fig. 1B). In total, 95% of the travelers will be used as samples for the prediction tasks. We did not incorporate the remaining 5% of travelers who have a large proportion of activities in less visited clusters ("Others"). Although they represent a unique aspect of travelers' mobility behavior, the sample size in this research is not representative enough to depict their movement predictability. A dataset with a longer time span may help gather enough samples about these travelers, whose movement predictability is a topic worth investigation. Note that we also don't consider user trajectories with a total length smaller than three ($M < 3$), which are too short to support the prediction task. Filtering such travelers gives us a total number of 97,685 user trajectories.

3.2. Sampling strategy for the prediction task

By measuring users' length of stay from the 97,685 trajectories, we find that the majority of travelers visited South Korea for only a few days (Fig. 2A). The median, mean and 95th percentile of length of stay are 3.0, 3.7 and 9.4 days, respectively. This means if the training samples (i.e., users) are selected randomly for the prediction task, users who stayed

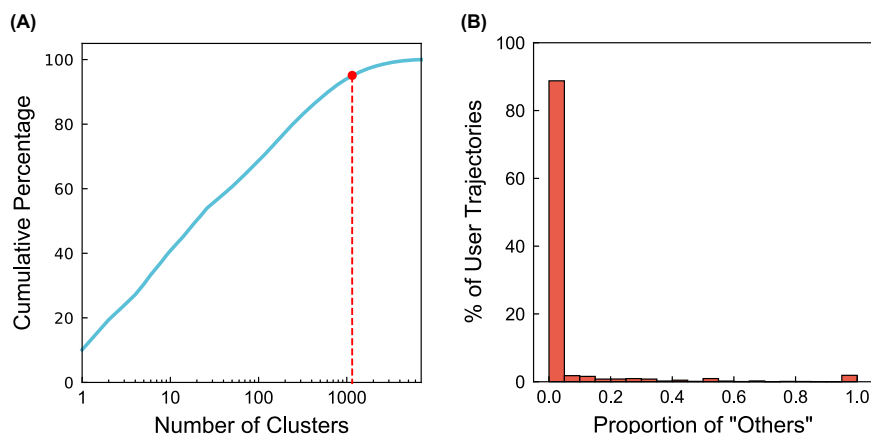

Fig. 1. (A) Cumulative percentage of visitation frequency of spatial clusters. (B) Distribution of percentage of "Others" locations traversed by user trajectories.

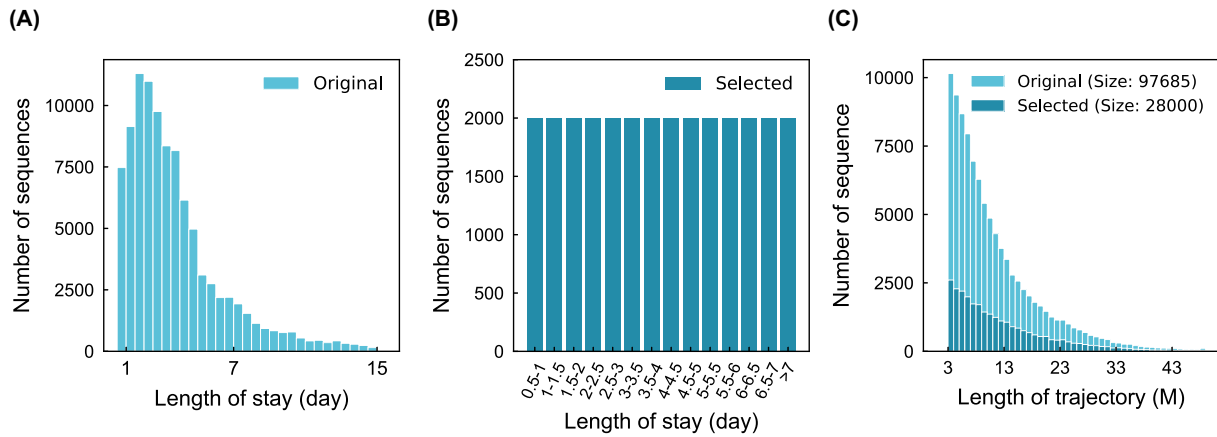

Fig. 2. (A) Length of stay of users generated from the 97,685 user trajectories. (B) Sampling strategy based on length of stay. (C) Length of user trajectories before and after performing the sampling (using one set of samples as an example).

in the country for a relatively long time will be severely under-represented. Therefore, we introduce a strategy by uniformly sampling users based on their duration of stay (Fig. 2B). This sampling strategy allows us to capture users with varying lengths of stay. It ensures that users who stayed in South Korea for only a few days do not dominate in the samples.

In order to yield robust results for the prediction analysis, we generate ten sets of samples. Each set of samples includes 28,000 user trajectories. In particular, by using length of stay as the selection criterion, we randomly select 2000 users from each sub-population at an interval of 0.5 days. Note that users who stayed over 7 days are considered as one single sub-population. This gives us $2000 \times 14 = 28,000$ samples. The prediction models will be performed and systematically compared using the ten sets of samples. Fig. 2C shows the distributions of trajectory length (i.e., number of cluster areas traversed by a user trajectory) before and after performing the data sampling. The median, mean and 95th percentile in original data (97,685 trajectories) are 8.0, 11.1 and 28, respectively. These numbers change to 10.0, 12.3 and 30 after trajectory sampling is performed.

3.3. Markov chain model

The first prediction model we use in this study is Markov chain. Given a set of possible states, a Markov chain models the transitions among states by assuming that the probability of transitioning to a future state is solely dependent on the current state. In the context of location prediction, the state space captures all possible locations a traveler could visit. To predict a traveler’s movement, the model assumes that the probability of moving to a particular location at a future time step $n + 1$ depends only on the traveler’s current location:

$$\Pr(X_{n+1}=l_{n+1} | X_1=l_1, X_2=l_2, \dots, X_n=l_n) = \Pr(X_{n+1}=l_{n+1} | X_n=l_n) \quad (1)$$

More precisely, the model used here is a first-order, discrete-time Markov chain. To build the model, as shown in Fig. 3, we establish a transition matrix that documents the probability of travelers moving from C_i to C_j :

$$p_{ij} = q_{ij} / \sum_j q_{ij} \quad (2)$$

Here q_{ij} denotes the total number of transitions from C_i to C_j captured from the user trajectories. Note that:

$$\sum_j p_{ij} = 1 \quad (3)$$

The transition matrix will then be used for the prediction task. The

performance of the model will be evaluated based on ten sets of samples generated in the previous step (Section 3.2). For each set of samples, 5-fold cross validation is adopted to evaluate the prediction accuracy.

Evaluating the Markov chain model would offer many practical and behavioral insights. First, due to simplicity of the model assumptions, the training data of Markov chain can be simple in its data structure. For instance, a simple matrix on the origin-destination (OD) trips is sufficient to build a prediction model. Thus, if the Markov chain model achieves a desirable performance, it would indicate that aggregate data on travelers’ movements could be useful in some operational settings when individual data is not accessible. Second, the performance of the Markov chain model would reveal the collective dynamics of travelers’ movements. The model is expected to perform well when travelers have uniform or converging movement patterns. However, when travelers have a remarkable diversity in their location choice and trip planning, the model may provide inaccurate predictions.

3.4. Recurrent neural network model

The Markov chain model leverages collective mobility patterns to make the prediction. However, the model does not take into account the long-term dependency of individual movements. Here, we introduce another prediction model with a Recurrent Neural Network (RNN) architecture. The model takes an individual’s location sequence as input, and outputs the likelihood of the next location visited by the traveler.

As shown in Fig. 4, the model consists of four building blocks, namely, a one-hot encoding layer, an embedding layer, a fully connected layer, and a softmax layer. The one-hot encoding layer is used to map each location (i.e., cluster area) to a one-hot feature vector. The size of the vector equals the total number of possible locations ($R = 1151$). Since these feature vectors are sparse, a usual practice is to further incorporate an embedding layer, which transforms these sparse features into low-dimensional, dense vectors. To model the temporal dependency of individual movements, we connect the embedding layer with a Long Short-term memory (LSTM) layer, an RNN architecture widely used over sequence data (Hochreiter & Schmidhuber, 1997). The LSTM layer takes the embedding of an individual’s location sequence as input, and outputs a feature vector h_{t+1} for the downstream task.² The LSTM layer is connected with a fully connected layer, and then a softmax layer which outputs the probability that each location (C_j) tends to be visited by the given individual in the next time step $t + 1$.

² Readers can refer to the appendix for a detailed description of the architecture of LSTM.

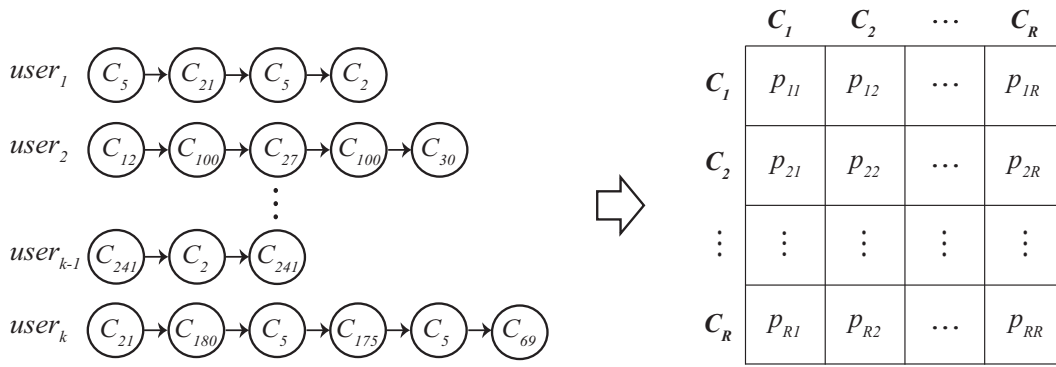

Fig. 3. Build transition probability matrix from travelers' movement trajectories.

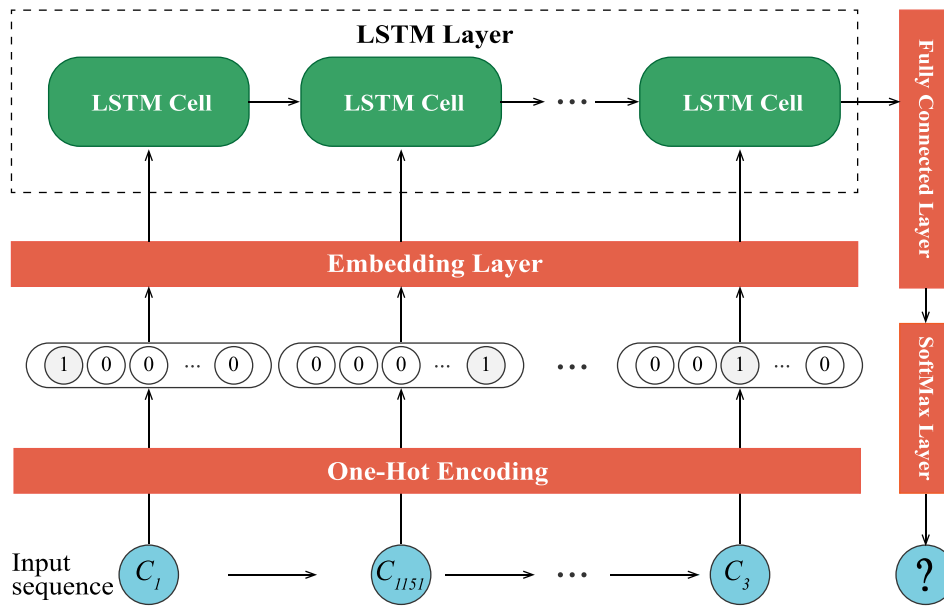

Fig. 4. LSTM model with a location embedding layer.

$$p(\text{loc} = C_i | h_{t+1}) = \frac{e^{z_i}}{\sum_{k=1}^R e^{z_k}} \tag{4}$$

Here z_i denotes the i th element of z , which is the output feature vector of the fully connected layer (size = 1151). There are two key parameters in the model, namely, the size of the embedding layer and the hidden vector size of the LSTM layer. The size of the embedding layer affects the expression of locations, namely, the mapping of one-hot location vectors to dense but lower-dimensional feature vectors. The hidden vector size controls the complexity of the LSTM layer and affects the layer's ability to model temporal dependencies in travelers' movements. The two parameters jointly shape the model's prediction capability. By testing various combinations of the two parameters, we adopt 400 (embedding) and 80 (LSTM) that yield the best overall performance. For simplicity, we refer to the proposed recurrent neural network model as LSTM model in the remaining of this article.

Comparing the LSTM model with Markov chain has notable implications. It would reveal whether or to what extent the long-term dependency of individual movement could help better predict travelers' whereabouts. Note that when making predictions, the LSTM model requires a fixed length of individual location sequence as the model input. In other words, we have to decide the number of prior locations to be used to predict an individual's next location. We name this parameter as L . When performing the 5-fold cross validation over ten sets of samples,

we test a series of values for L and evaluate their impacts on the prediction accuracy.

3.5. Evaluation metrics

At the prediction stage, both the Markov chain and the LSTM model output a list of locations sorted by the probability of being visited by a traveler. A common metric for the model performance is Acc@K, which measures whether an individual's next location can be captured by the top K predicted locations. In this study, we evaluate travelers' mobility predictability from a few perspectives. First, we evaluate the two models' overall accuracy by computing the percentage of successful predictions under a specific K (e.g., Acc@1, Acc@3, Acc@5).

We also evaluate the prediction accuracy for each individual traveler by measuring the proportion of successful predictions. For instance, given a traveler with trajectory length $M = 11$, the Markov chain model can be used to predict the traveler's next location for ten times (from time step $t = 2$ to $t = 11$). If the top one prediction (Acc@1) successfully captures the traveler's next move for five times, the accuracy would be $5/10 = 0.5$. A large value indicates that the traveler's movements are highly predictable under a specific model setting.

4. Analysis results

4.1. Movement predictability and inter-personal variations

In this section, we evaluate travelers' movement predictability by comparing the overall performance of the two models. Since the LSTM model requires L as the length of input sequence, we first evaluate how the parameter choice impacts prediction accuracy. Fig. 5A shows the mean value of Acc@1 metric of ten trials under different L values, with error bars representing the one standard deviations. Each trial is based on one set of user trajectories generated in the sampling stage. The result suggests that larger values of L generally yield better prediction performance. However, the improvement becomes relatively small when L is larger than 6. Therefore, in the remaining of the paper, we adopt $L = 6$ as the parameter choice (named as LSTM6 model). Note that we also train LSTM2, LSTM3, LSTM4 and LSTM5 models to support our analysis when the input sequence is not long enough. For instance, when predicting an individual's location at $t = 4$, since only three locations were visited by the traveler prior to the next move, we will use the trained LSTM3 model to make the prediction.

Fig. 5B shows the overall performance of the two models. In general, the LSTM model achieves better prediction accuracy than the Markov chain, but their difference becomes smaller as K increases. When K equals 1, the Markov chain model could accurately predict a traveler's next location for 33.4% of the times, compared to 41.9% for LSTM. The error bars show small variations of prediction accuracy over ten trials, which indicates the robustness of our findings. The Acc@3 metrics are 54.0% for Markov chain, and 59.7% for LSTM. When using the top 5 predictions (Acc@5), the two models could capture a traveler's next move for 64.2% (Markov) and 67.7% (LSTM) of the times, respectively. The results suggest that although travelers' movements are perceived to be less routine than some other population groups such as residents, they still exhibit a notable level of predictability.

However, both models reveal a large inter-personal variation. Fig. 5C shows the distribution of prediction accuracy of individuals at different K values. For instance, the movements of many travelers cannot be well predicted by the Markov chain under $K = 1$ (e.g., accuracy close to 0%). This is because the Markov chain model is based on the transition probabilities among locations. Travelers whose movement patterns deviate significantly from the majority are likely to be less predictable. Interestingly, the inter-personal variation becomes smaller for LSTM, no matter which K is chosen. This means the LSTM model could narrow the difference between travelers (in prediction accuracy) by capturing the long-term dependencies in their movements. When $K = 3$, the two models achieve a prediction accuracy over 50% (Markov chain) and 60% (LSTM) respectively for at least half of the travelers. The median prediction accuracy increases to 67% (Markov chain) and 69% (LSTM)

when $K = 5$. The results in Fig. 5B and C suggest that the two models achieve a good overall performance especially when K is large. However, the models' prediction capabilities are largely unequal across individual travelers.

4.2. Impact of length of stay

In this section, we further examine the associations between travelers' movement predictability and length of stay in South Korea. According to the results of Markov chain model, as shown in Fig. 6A–C, travelers' movement predictability tends to peak when length of stay is between two and four days. When length of stay exceeds four days, movement predictability tends to decrease as travelers stayed longer. It is important to mention that in the sampling stage, travelers are uniformly sampled based on length of stay (Fig. 2B). In other words, the variations in movement predictability are not affected by sampling bias, but the actual mobility patterns. Since Markov chain makes predictions based on transition probabilities, it is possible that travelers with a long duration of stay had distinctive movement patterns compared to the majority of others. Therefore, the Markov chain model achieves a lower prediction accuracy for these travelers.

However, when applying the LSTM model, the prediction accuracy over these "long-term" visitors (e.g., length of stay >4 days) is notably improved (Fig. 6D–F). In particular, movement predictability remains relatively stable across travelers with varying lengths of stay. It suggests that the LSTM model is able to capture the long-term dependency of individual mobility, which helps better predict the movements of certain travelers. For instance, some long-term visitors could repeatedly visit their favorite places over and over again. Although these places might not be of interests to other travelers, the LSTM model will be able to learn from these recurrent movement patterns to make better predictions.

The results in Fig. 6 suggest that the better performance of LSTM (over Markov chain) is largely attributed to the model's improved ability in predicting movements of long-term visitors. It also explains why LSTM model yields a smaller inter-personal variation in prediction accuracy (Fig. 5C).

4.3. Impact of trajectory length

We next examine the relationship between trajectory length (M) and movement predictability. Intuitively, trajectory length denotes the total number of locations traversed by a traveler during the whole journey. A larger M , especially when length of stay is controlled, indicates more active travel patterns. Therefore, it would be interesting to investigate how this activeness relates to movement predictability. As shown in Fig. 7, for both models, travelers' movement predictability generally

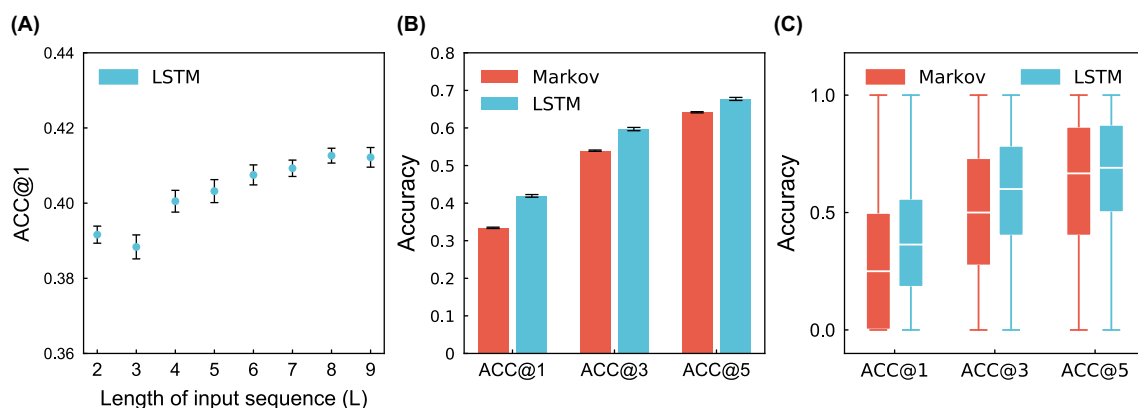

Fig. 5. (A) Acc@1 metric of LSTM model under varying input sequence lengths. (B) Overall model performance: Markov vs. LSTM. (C) Individual variations of movement predictability.

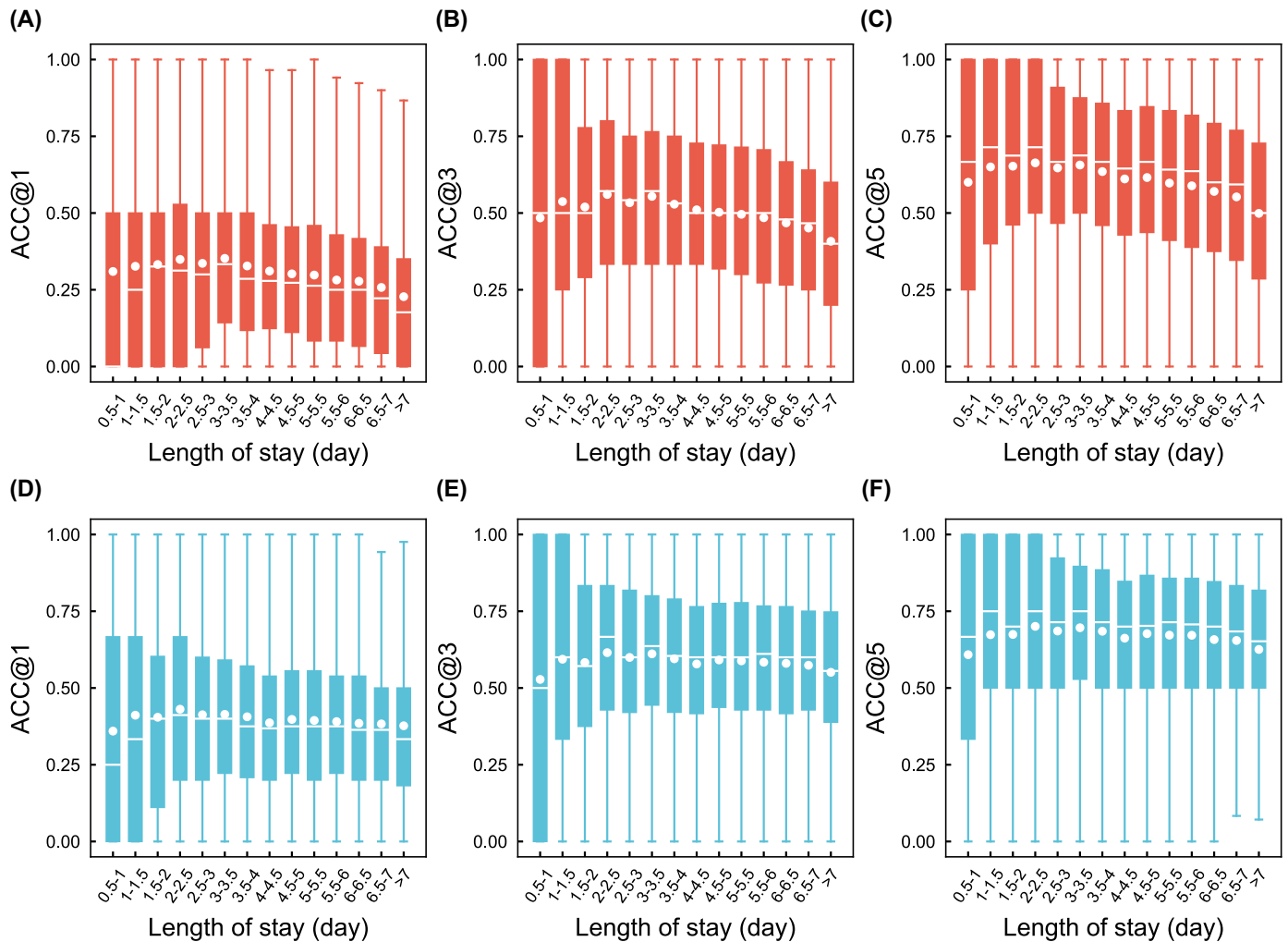

Fig. 6. Relationship between movement predictability and length of stay of travelers: (A–C) results of Markov chain model; (D–F) results of LSTM model.

increases with M . However, after controlling for length of stay (Fig. B.2 in Appendix), such relationship seems to hold only for travelers who stayed in South Korea for a relatively long time (e.g., >4 days). The results suggest that among these long-term visitors, movement predictability is generally higher for those with more active travel patterns.

There are a few possible reasons which lead to the observed relationship for these long-term visitors. First, it is possible that some visitors with a large M are “returners”, whose travel patterns are characterized by frequent and repetitive visits to some locations (Papalardo et al., 2015). In this sense, their travel patterns could be more predictable. Another factor is related to the visitors’ travel time budget. Sometimes, a larger M means that travelers need to reach many different locations during a limited amount of time. Given the constraints in time budget, it is possible that some travelers would end up with similar routes and visitation patterns that are subject to the availability of transportation services, opening hours of tourism attractions, and itineraries recommended by travel agencies. These collective behavioral choices could have a joint impact on travelers’ movement predictability.

The results in Fig. 7 lead to another intriguing question—Is it possible that travelers’ movement predictability would vary at different stages of their journeys? For instance, given two travelers with a similar length of stay but different trajectory lengths ($M = 10$ vs. $M = 20$), is it possible that our models are equally effective when predicting their first ten locations, but more or less effective when predicting the remaining ten locations of the more active traveler? To address this question, we introduce *journey ratio* to quantify the relative position of a given

location in a traveler’s trajectory. For instance, when the prediction is performed over the 5th location of a traveler with $M = 10$, the journey ratio is computed as $5/10 = 0.5$. With this indicator, we are able to organize travelers by length of stay (e.g., at an interval of 1 day), and then compute the overall prediction accuracy of the two models at different stages of travelers’ journeys (i.e., different journey ratios). As shown in Fig. 8, we find that after controlling for length of stay, travelers’ movement predictability remains relatively stable except at the initial and final stages of their journeys. The higher prediction accuracy at the two ends may partially be attributed to the converging behaviors of travelers at “gateway” cities, such as those with international airports, harbors and other points of entry & exit (Lew & McKercher, 2002). The results in Fig. 8 indicate that travelers’ movement predictability does not vary significantly at different stages of their journeys. This also reaffirms our finding that the higher movement predictability of active travelers, as shown in Fig. 7, take root in their unique space-time behaviors.

4.4. Movement predictability within and across cities

Since the mobile phone dataset covers the entire South Korea, it offers us a unique opportunity for investigating the geographic heterogeneity of movement predictability. In this section, we first discuss the two models’ performance when the prediction is made over intra-city or cross-city trips. Intra-city trips are defined as movements that occurred within a city, while cross-city trips refer to movements that crossed city boundaries. Since travelers could visit more than one city during their

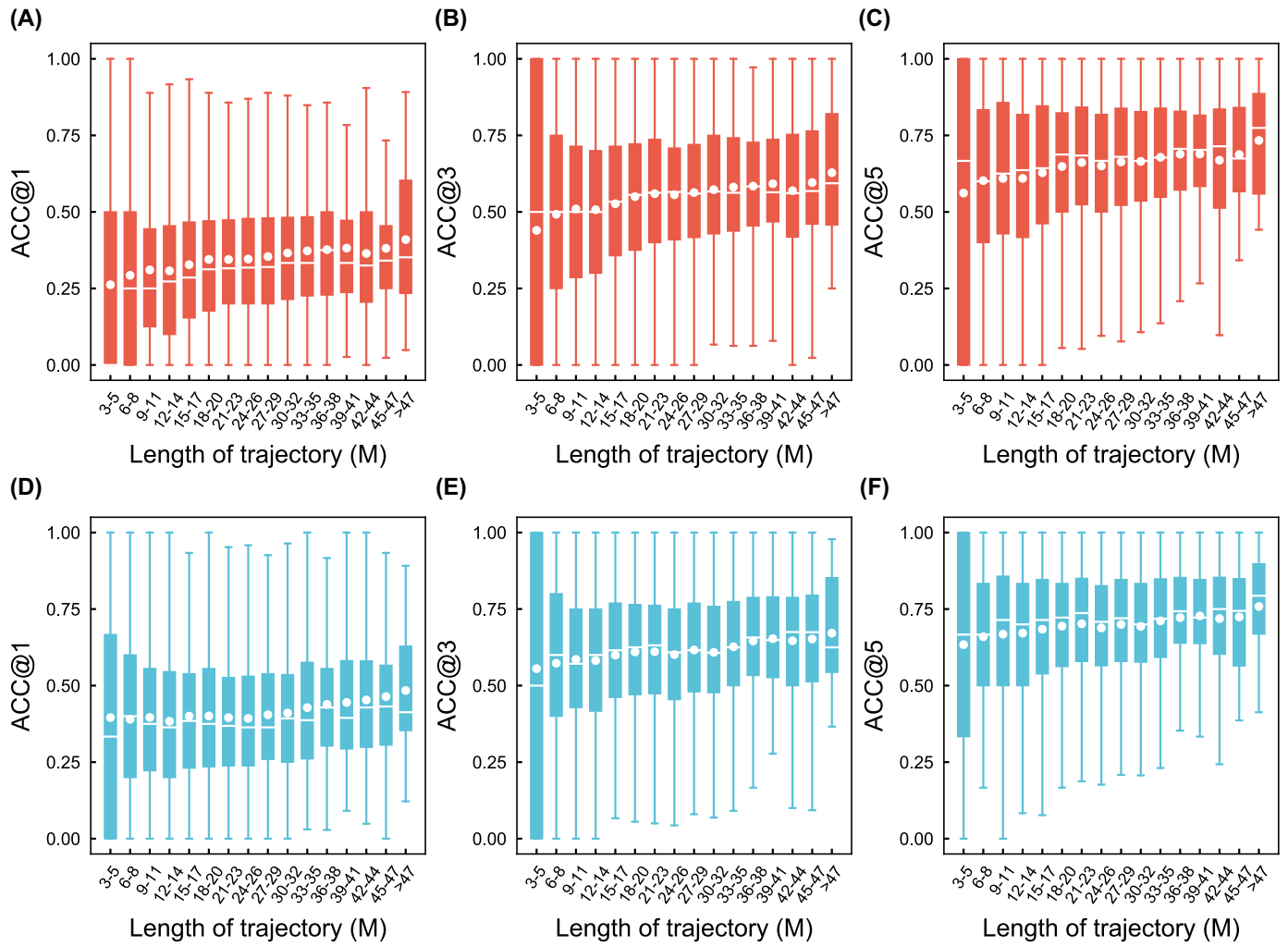

Fig. 7. Relationship between movement predictability and trajectory length: (A–C) results of Markov chain model; (D–F) results of LSTM model.

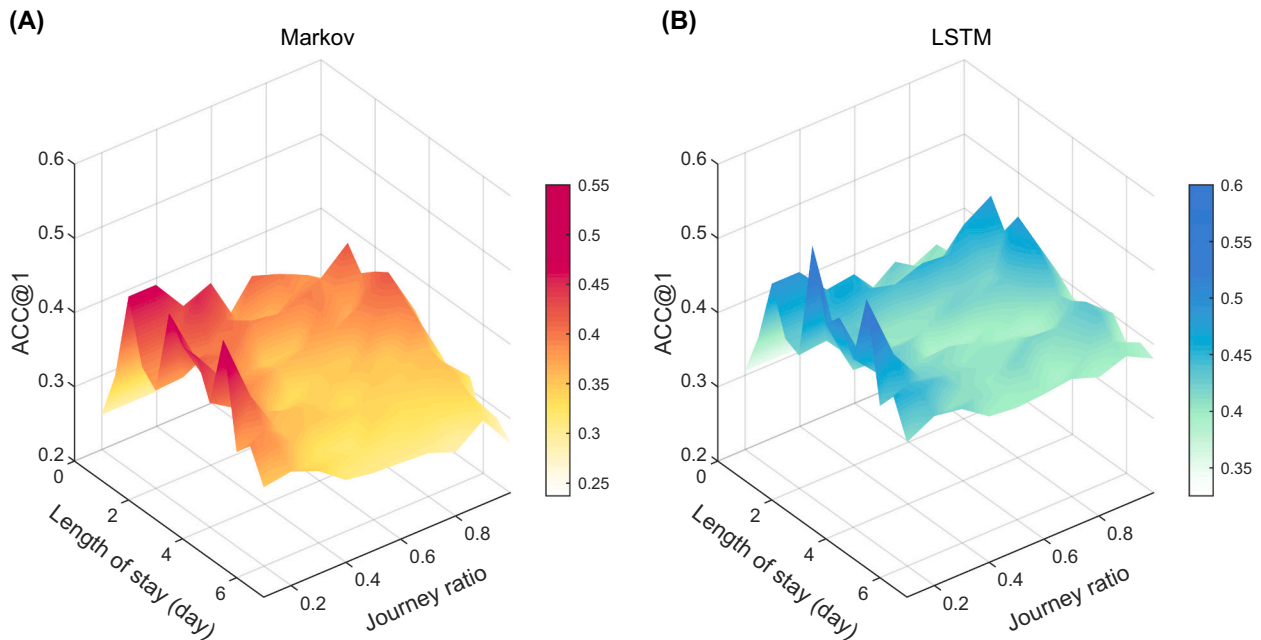

Fig. 8. Movement predictability of travelers at different stages of their journeys.

journeys, the models' prediction capabilities could vary at different geographic scales. Thus, we compute the two models' prediction accuracy following the city boundaries in South Korea. As shown in Fig. 9, both models show a notable difference in predicting the two types of movements. The prediction accuracy over intra-city movements is much higher than that of cross-city movements. The results suggest that it is challenging to pinpoint travelers' next location when they were heading to another city. This is to some extent expected because travelers' location choices can be quite diverse when switching to a new destination. The results also indicate that the models' performance is comparatively good when the focus is on intra-city trips. The Markov chain achieves an overall accuracy of 39.7% for Acc@1, 62.8% for Acc@3, and 72.1% for Acc@5 (Fig. 9A), compared to 46.3%, 68.5% and 76.7% for the LSTM model (Fig. 9B).

Many real-world applications that involve the prediction and recommendation of tourist activities are developed for specific cities or destinations. Therefore, it is meaningful to study how movement predictability varies across cities. To achieve this purpose, we compute the two models' prediction accuracy in each city by focusing on intra-city movements. As shown in Fig. 10A, we compute the total number of travelers who visited each city during the study period. Fig. 10B and C shows, respectively, the Acc@1 metric for the Markov chain model and LSTM model. Cities with less than 380 travelers are not included in this analysis. We find that travelers' movement predictability varies notably across cities. That means even the same model could yield varying levels of prediction accuracy when applied in different urban settings.

By further relating cities' Acc@1 metrics with total number of travelers, as shown in Fig. 11A and B, we find that the number of travelers who visited a city is not a decisive factor of movement predictability. In particular, cities with fewer travelers have a large variation in prediction accuracy. As the number of travelers gradually increases, we observe a general convergence of the Acc@1 metric for both models. Note that our mobile phone dataset only covers a period of two weeks. Therefore, the number of travelers computed for cities, which is subject to factors such as seasonality in tourism and types of travelers, might not be representative of their overall attractiveness. Although this analysis does not allow for a definitive conclusion, it is possible that popular cities or destinations are mixed with visitors with similar mobility preferences and those with very unique travel behaviors. Such mixings may have a neutralizing effect on the models' prediction accuracy.

As a final step, we compare cities' Acc@1 metrics from the two models. As illustrated in Fig. 11C, the two models' overall performance is highly correlated, with the LSTM model performing better over

majority of the cities. By highlighting some key tourism destinations such as Seoul, Jeju-do, Incheon and Busan, we find that the two models have similar prediction accuracy in these cities. As the Markov chain model can be built over data such as OD matrices, the result suggests that when individual-level data is not accessible, using aggregate mobility observations may achieve compatible overall performance, but subject to a possible larger inter-personal variation, as suggested by Fig. 5C.

5. Discussion and conclusion

This study investigates the movement predictability of international travelers using a nationwide mobile phone dataset collected in South Korea. Two prediction models, the first being Markov chain and the second with a recurrent neural network architecture (LSTM), are established to achieve this purpose. The results reveal a comprehensive, yet complex relationship between movement predictability and other factors, such as travelers' length of stay in the country, activeness in their travel patterns, and where the movements were conducted.

Although tourism activities are regarded as "an escape of daily routine", our results suggest that travelers' movements still exhibit a notable level of predictability. In particular, the Markov chain model yields an overall prediction accuracy between 33.4% (Acc@1) and 64.2% (Acc@5), compared to 41.9% and 67.7% for the LSTM model. The LSTM model performs generally better, due to its ability to learn from long-term dependencies in individual movements. However, the prediction capabilities of both models are largely unequal across individual travelers.

By examining movement predictability and travelers' length of stay based on results of the Markov chain model, we find that the prediction accuracy tends to peak when length of stay is between two and four days. The model's performance tends to decrease as travelers stayed longer (>4 days). However, this gap is filled when the LSTM model is applied. The comparison suggests that travelers' movement predictability is model dependent. On the one hand, these "long-term" visitors could have relatively unique travel patterns compared to others. Therefore, the Markov chain model, which is solely based on transition probabilities, performs less well. On the other hand, some unique aspects of long-term visitors—such as recurrent visits to certain locations—may be captured by the LSTM model, thus improving the model's prediction capabilities.

By associating movement predictability with length of trajectory, we find that travelers who visited more places during their journeys tend to be more predictable. However, this conclusion seems to hold only for

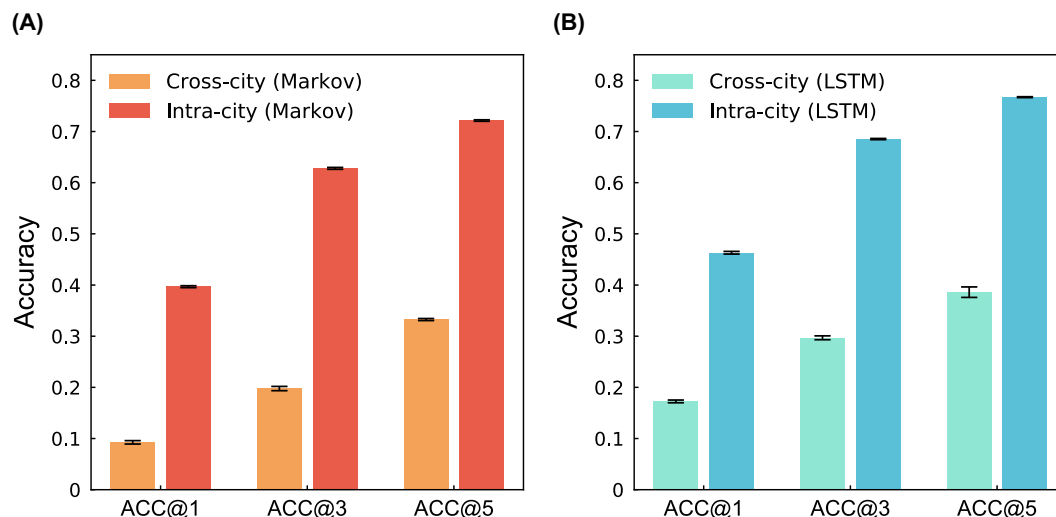

Fig. 9. Prediction accuracy over intra-city and cross-city trips: (A) Markov chain model; (B) LSTM model.

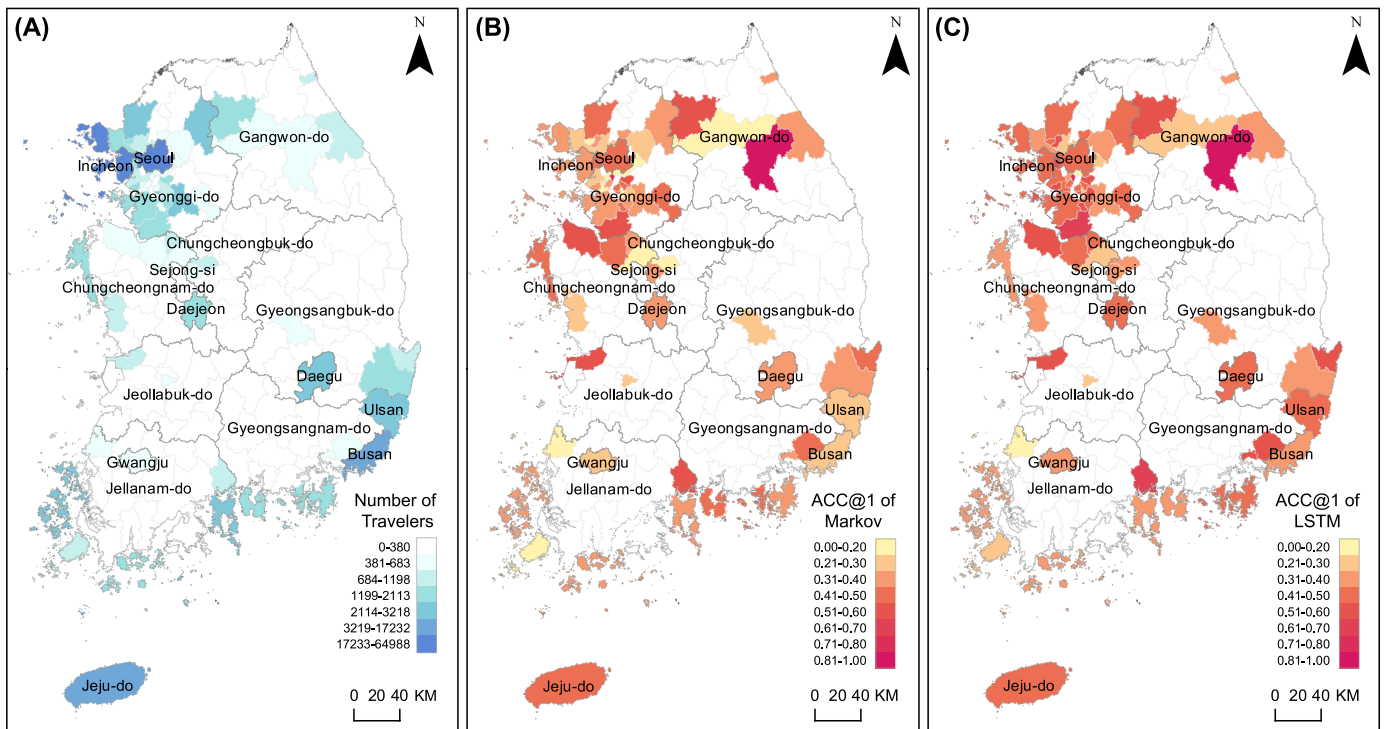

Fig. 10. (A) Total number of travelers to each city derived from the mobile phone dataset. (B) Acc@1 metric of intra-city trips for each city based on the Markov chain model. (C) Acc@1 metric of intra-city trips for each city based on the LSTM model.

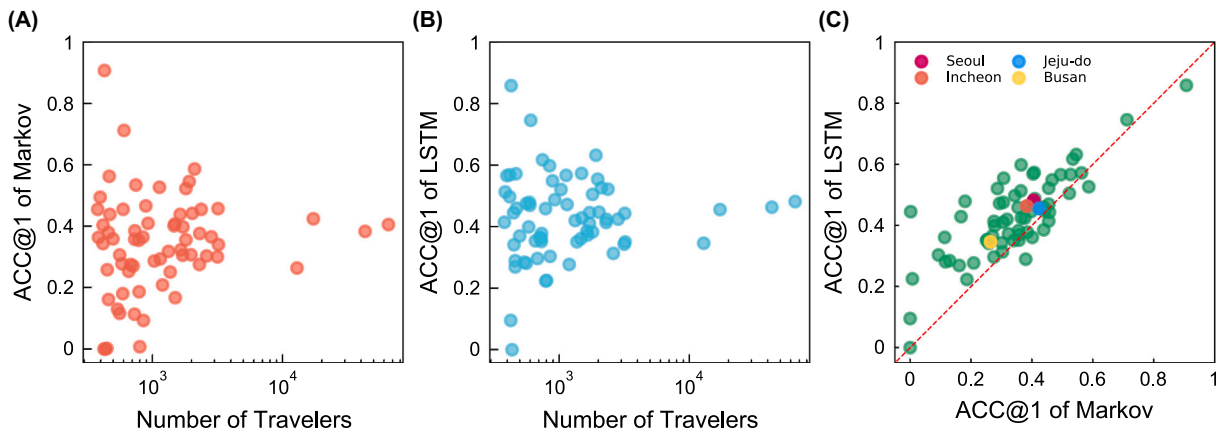

Fig. 11. (A) Relationship between cities' Acc@1 metrics of Markov chain model and total number of travelers. (B) relationship between cities' Acc@1 metrics of LSTM model and total number of travelers. (C) relationship between cities' Acc@1 metrics of Markov chain model and LSTM model.

those who stayed in South Korea for a relatively a long time (e.g., >4 days). Frequent and repetitive visits to certain locations (i.e., the so-called “returners”), and constrains in time budget which result into similar route or visitation patterns are two possible reasons that lead to the observed relationship. The result also indicates that for “short-term” visitors (e.g., length of stay <4 days), movement predictability does not increase with activeness in travel patterns.

Finally, we examine how well travelers' movements can be predicted when they were moving within a city or heading towards another. The results show that both models perform less well over cross-city movements, with their Acc@5 metrics being 33.3% (Markov) and 38.6% (LSTM). By further investigating intra-city movements, we observe spatial heterogeneity in the models' performance, meaning that travelers' movements are more predictable in some cities, but less in others. The level of predictability is not correlated with the total number of travelers who visited the cities. The variations in movement

predictability is likely to be influenced by other characteristics of cities that shape individual travel and collective behavioral dynamics (e.g., spatial organization of attractions, deployment of transportation services, social background of visitors).

The results in this study suggest that structures of input data, configuration of prediction models, and geographic contexts of tourism destinations have a joint impact on how we interpret and predict travelers' movements. Given that next-location prediction has many application scenarios, we want to discuss several implications of this research regarding the deployment of tourism services in cities:

- Individual level data such as travelers' cellphone trajectories are perceived to contain more valuable information on human mobility, but also more difficult to acquire, and may raise concerns on privacy issues. Our study suggests that prediction models built upon aggregate movements (e.g., OD matrices) can also achieve desirable

results in many cities. Because visitors could have similar travel arrangements or decision processes, sometimes a simple model which is less picky on input data (e.g., Markov chain) can be useful in assisting tourism service deployment (e.g., location and activity recommendations).

- On the downside, these simple models tend to favor collective preferences, thus overlooking the behavioral needs of specific population groups. For instance, the Markov chain model reports varying levels of prediction accuracy over travelers with different characteristics. Differential strategies can thus be deployed over different population groups. In particular, sub models can be trained and used over different types of travelers, such as same-day vs. overnight stayers, and short-term vs. long-term visitors. Since length of stay is usually predetermined before actual trips (Alegre & Pou, 2006), such information — which may be available to tourism service providers (e.g., hotel booking & flight itinerary) — can be leveraged to offer customized recommendations.
- There is a notable geographic variation in the two models' prediction accuracy. The finding suggests that our abilities to predict travelers' movements tend to differ across cities or destinations. It also indicates that there is no "one-model-fits-all" solution. Building local models which consider urban and tourist behavioral contexts may further improve quality of tourism services and therefore tourist experiences.
- Although travelers' movements are partially shaped by administrative divisions, previous studies have shown that travel arrangements do not always follow boundaries of cities or destinations (Paulino, Lozano, & Prats, 2021). Although financial resources, data, and service deployment are often separated across tourism destinations, a holistic model that can tackle cross-scale tourist movements can be beneficial. Our study suggests that accurately predicting the next place for a cross-city trip is still challenging. However, multi-task models can be built to support next-location and next-city predictions at the same time. Instead of pinpointing where a traveler will visit when entering a new city, predicting the next city to be visited can be less challenging, and may further improve service deployment at tourism destinations (e.g., recommending locations & activities to travelers based on prediction results).

We want to point out a few limitations of this research. First, the two prediction models are applied over places derived from a spatial clustering algorithm to mitigate uncertainty issues in mobile phone data. According to the threshold used in the clustering algorithm (Δd), these places could have a radius up to $2km$. Therefore, movement predictability of travelers could be lower at finer spatial resolutions. Other types of mobility observations such as GPS data (Pettersson & Zillinger, 2011; Shoval & Ahas, 2016; Zheng et al., 2017) and geolocated social

media (Shao, Zhang, & Li, 2017; Sun et al., 2019) may complement our findings by revealing travelers' movement predictability at POI (point of interest) level. Note that these data sources also come up with other issues, such as limited sample sizes (GPS) and sparsity of users' records (check-in data & geotagged photos). Future studies could compare or even combine different data sources to obtain a more holistic picture of tourist travel behavior. Second, this study uses a constant threshold in the spatial clustering algorithm. Although this practice ensures that movement predictability is assessed under the same spatial scale, the method does not consider the varying impact of cellphone tower densities across the study area. For example, cellphone towers in certain areas (e.g., rural areas or areas in cities with a low population density) tend to be sparsely distributed. A spatially adaptive approach by considering the spatial heterogeneity may yield new representations of places that are useful to certain prediction and location recommendation tasks. This is a possible direction for future work. Third, characteristics of places can reveal travelers' activity purposes (Tu et al., 2017; Zhang et al., 2020; Zhu et al., 2020), therefore can be incorporated into the prediction models to further enhance their performance. Such information is not leveraged in the current study (e.g., number or percentage of POIs by type in each spatial cluster), due to challenges in collecting nationwide POI data in South Korea. In the future, it would be meaningful to investigate the impact of place characteristics on the prediction outcome, for example, to understand types of locations in movement sequence that yield high predictability. The characteristics of locations can be also incorporated into the models to further improve prediction accuracy. Moreover, the mobile phone dataset only covers a period of two weeks, therefore does not capture the potential seasonality in tourism activities (Ahas, Aasa, Mark, Pae, & Kull, 2007). Longitudinal datasets with longer time spans could reveal possible variations in movement predictability due to seasonal changes in travel behavior. Nevertheless, we believe this research serves as an important effort in revealing the movement predictability of travelers at a large scale and over a highly representative population. The analytical framework and findings can be used to inform tourism planning and service deployment in cities.

Acknowledgement

The authors would like to thank the anonymous reviewers for their valuable comments on earlier versions of the manuscript. This research was jointly supported by the Hong Kong Polytechnic University Research Grant (ZVN6; 1-BE0J) and the National Natural Science Foundation of China (No. 41801372; No. 42171454; No. 41971345), the Ministry of Education of the Republic of Korea and the National Research Foundation of Korea (NRF2019S1A3A2098438).

Appendix A. Architecture of LSTM module

Long Short-Term Memory (LSTM) is a Recurrent Neural Network (RNN) architecture capable of learning temporal dependencies in sequence data. A LSTM network consists a chain of repeating modules that share the same structure. Each module takes input from the previous time step, and combines it with new information to make predictions. As shown in Fig. A.1, a LSTM module consists of several key components, namely, a cell state and three gates (forget gate, input gate and output gate). The cell state combines information from the forget gate and input gate, and is updated each time step. The forget gate (f_t) receives the output of previous time step (h_{t-1}) and input vector of current time step (x_t), and uses a sigmoid layer to determine what information should be retained or thrown away (Eq. (5)). The input gate (i_t) controls what new information from h_{t-1} and x_t will be added to the cell state (Eqs. (6)–(8)). Finally, the output gate (o_t) uses a sigmoid layer by taking h_{t-1} and x_t (Eq. (9)), and its output is coupled with a filtered version of cell state C_t to derive the module output h_t (Eq. (10)). The learnable parameters of LSTM are continuously updated in the training stage. In this research, the input of the LSTM layer (Fig. 4) is a sequence of vectors (embedding) that denote the locations traversed by a traveler. The final output of the LSTM model is a vector that summarizes the probability that each location will be visited by the traveler in the next time step.

$$f_i = \sigma(W_f \cdot [h_{t-1}, x_t] + b_f) \tag{5}$$

$$i_t = \sigma(W_i \cdot [h_{t-1}, x_t] + b_i) \tag{6}$$

$$\tilde{C}_t = \tanh(W_C \cdot [h_{t-1}, x_t] + b_C) \tag{7}$$

$$C_t = f_i * C_{t-1} + i_t * \tilde{C}_t \tag{8}$$

$$o_t = \sigma(W_o \cdot [h_{t-1}, x_t] + b_o) \tag{9}$$

$$h_t = o_t * \tanh(C_t) \tag{10}$$

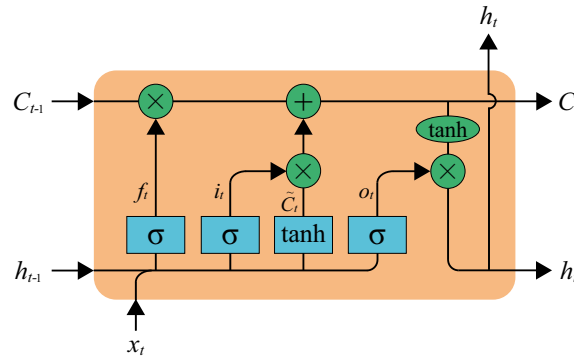

Fig. A.1. Structure of an LSTM module.

Appendix B. Relationship between movement predictability and trajectory length when controlling for travelers' length of stay

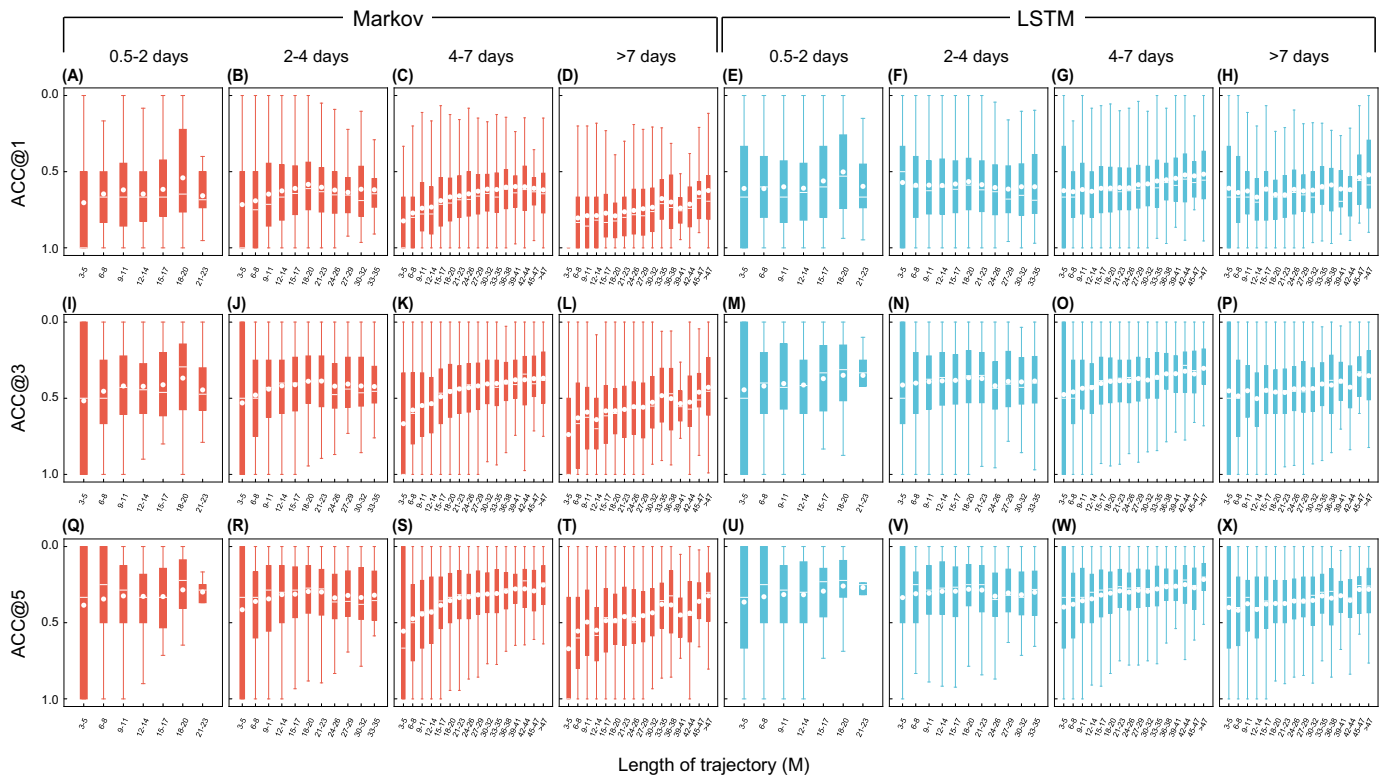

Fig. B.2. Relationship between movement predictability and trajectory length after controlling for travelers' length of stay.

References

Ahas, R., Aasa, A., Mark, Ü., Pae, T., & Kull, A. (2007). Seasonal tourism spaces in Estonia: Case study with mobile positioning data. *Tourism management*, 28(3), 898–910.

Alegre, J., & Pou, L. (2006). The length of stay in the demand for tourism. *Tourism management*, 27(6), 1343–1355.

Blondel, V. D., Decuyper, A., & Krings, G. (2015). A survey of results on mobile phone datasets analysis. *EPJ data science*, 4(1), 10.

Calabrese, F., Di Lorenzo, G., & Ratti, C. (2010). Human mobility prediction based on individual and collective geographical preferences. In *13th international IEEE conference on intelligent transportation systems* (pp. 312–317). IEEE.

Cho, E., Myers, S. A., & Leskovec, J. (2011). Friendship and mobility: User movement in location-based social networks. In *Proceedings of the 17th ACM SIGKDD international conference on Knowledge discovery and data mining* (pp. 1082–1090).

Gambis, S., Killijian, M.-O., & del Prado Cortez, M. N. (2012). Next place prediction using mobility markov chains. In *Proceedings of the first workshop on measurement, privacy, and mobility* (pp. 1–6).

Gonzalez, M. C., Hidalgo, C. A., & Barabási, A.-L. (2008). Understanding individual human mobility patterns. *Nature*, 453(7196), 779.

- Goulet-Langlois, G., Koutsopoulos, H. N., Zhao, Z., & Zhao, J. (2017). Measuring regularity of individual travel patterns. *IEEE Transactions on Intelligent Transportation Systems*, 19(5), 1583–1592.
- Hawelka, B., Sitko, I., Beinat, E., Sobolevsky, S., Kazakopoulos, P., & Ratti, C. (2014). Geo-located twitter as proxy for global mobility patterns. *Cartography and Geographic Information Science*, 41(3), 260–271.
- Hochreiter, S., & Schmidhuber, J. (1997). Long short-Term memory. *Neural computation*, 9(8), 1735–1780.
- Isaacman, S., Becker, R., áceres, R. C., Martonosi, M., Rowland, J., Varshavsky, A., & Willinger, W. (2012). Human mobility modeling at metropolitan scales. In *Proceedings of the 10th international conference on Mobile systems, applications, and services* (pp. 239–252).
- Jiang, S., Ferreira, J., & González, M. C. (2017). Activity-based human mobility patterns inferred from mobile phone data: A case study of Singapore. *IEEE Transactions on Big Data*, 3(2), 208–219.
- Lau, G., & McKercher, B. (2006). Understanding tourist movement patterns in a destination: A gis approach. *Tourism and hospitality research*, 7(1), 39–49.
- Le-Klaehn, D.-T., & Hall, C. M. (2015). Tourist use of public transport at destinations-A review. *Current Issues in Tourism*, 18(8), 785–803.
- Lew, A. A., & McKercher, B. (2002). Trip destinations, gateways and itineraries: The example of Hong Kong. *Tourism Management*, 23(6), 609–621.
- Li, Q., Zheng, Y., Xie, X., Chen, Y., Liu, W., & Ma, W.-Y. (2008). Mining user similarity based on location history. In *Proceedings of the 16th ACM SIGSPATIAL international conference on Advances in geographic information systems* (pp. 1–10).
- Lu, X., Wang, C., Yang, J.-M., Pang, Y., & Zhang, L. (2010). Photo2trip: Generating travel routes from geo-Tagged photos for trip planning. In *Proceedings of the 18th ACM international conference on Multimedia* (pp. 143–152).
- McKercher, B., Shoval, N., Ng, E., & Birenboim, A. (2012). First and repeat visitor behaviour: Gps tracking and gis analysis in Hong Kong. *Tourism Geographies*, 14(1), 147–161.
- Orellana, D., Bregt, A. K., Ligtenberg, A., & Wachowicz, M. (2012). Exploring visitor movement patterns in natural recreational areas. *Tourism Management*, 33(3), 672–682.
- Pappalardo, L., Simini, F., Rinzivillo, S., Pedreschi, D., Giannotti, F., & Barabási, A.-L. (2015). Returners and explorers dichotomy in human mobility. *Nature communications*, 6(1), 1–8.
- Park, S., Xu, Y., Jiang, L., Chen, Z., & Huang, S. (2020). Spatial structures of tourism destinations: A trajectory data mining approach leveraging mobile big data. *Annals of Tourism Research*, 84, 102973.
- Paulino, I., Lozano, S., & Prats, L. (2021). Identifying tourism destinations from tourists' travel patterns. *Journal of Destination Marketing & Management*, 19, 100508.
- Pettersson, R., & Zillinger, M. (2011). Time and space in event behaviour: Tracking visitors by gps. *Tourism Geographies*, 13(1), 1–20.
- Raun, J., Ahas, R., & Tiru, M. (2016). Measuring tourism destinations using mobile tracking data. *Tourism Management*, 57, 202–212.
- Rodriguez, X. A., Martinez-Roget, F., & Gonzalez-Murias, P. (2018). Length of stay: Evidence from santiago de compostela. *Annals of Tourism Research*, 68, 9–19.
- Saluveer, E., Raun, J., Tiru, M., Altin, L., Kroon, J., Snitsarenko, T., Aasa, A., & Silm, S. (2020). Methodological framework for producing national tourism statistics from mobile positioning data. *Annals of Tourism Research*, 81, 102895.
- Shao, H., Zhang, Y., & Li, W. (2017). Extraction and analysis of city's tourism districts based on social media data. *Computers, Environment and Urban Systems*, 65, 66–78.
- Shoval, N., & Ahas, R. (2016). The use of tracking technologies in tourism research: The first decade. *Tourism Geographies*, 18(5), 587–606.
- Solomon, A., Livne, A., Katz, G., Shapira, B., & Rokach, L. (2021). Analyzing movement predictability using human attributes and behavioral patterns. *Computers, Environment and Urban Systems*, 87, 101596.
- Song, C., Qu, Z., Blumm, N., & Barabási, A.-L. (2010). Limits of predictability in human mobility. *Science*, 327(5968), 1018–1021.
- Sun, X., Huang, Z., Peng, X., Chen, Y., & Liu, Y. (2019). Building a model-Based personalised recommendation approach for tourist attractions from geotagged social media data. *International Journal of Digital Earth*, 12(6), 661–678.
- Tu, W., Cao, J., Yue, Y., Shaw, S.-L., Zhou, M., Wang, Z., Chang, X., Xu, Y., & Li, Q. (2017). Coupling mobile phone and social media data: A new approach to understanding urban functions and diurnal patterns. *International Journal of Geographical Information Science*, 31(12), 2331–2358.
- Xia, J. C., Zeephongsekul, P., & Arrowsmith, C. (2009). Modelling spatio-Temporal movement of tourists using finite markov chains. *Mathematics and Computers in Simulation*, 79(5), 1544–1553.
- Xia, J. C., Zeephongsekul, P., & Packer, D. (2011). Spatial and temporal modelling of tourist movements using semi-Markov processes. *Tourism Management*, 32(4), 844–851.
- Xiao-Ting, H., & Bi-Hu, W. (2012). Intra-Attraction tourist spatial-Temporal behaviour patterns. *Tourism Geographies*, 14(4), 625–645.
- Xu, Y., Shaw, S.-L., Zhao, Z., Yin, L., Fang, Z., & Li, Q. (2015). Understanding aggregate human mobility patterns using passive mobile phone location data: A home-based approach. *Transportation*, 42(4), 625–646.
- Xu, Y., Belyi, A., Bojic, I., & Ratti, C. (2018). Human mobility and socioeconomic status: Analysis of Singapore and Boston. *Computers, Environment and Urban Systems*, 72, 51–67.
- Xu, Y., Li, X., Shaw, S.-L., Lu, F., Yin, L., & Chen, B. Y. (2020). Effects of data preprocessing methods on addressing location uncertainty in mobile signaling data. *Annals of the American Association of Geographers*, 1–25.
- Xu, Y., Li, J., Belyi, A., & Park, S. (2021). Characterizing destination networks through mobility traces of international tourists-A case study using a nationwide mobile positioning dataset. *Tourism Management*, 82, 104195.
- Xu, Y., Li, J., Xue, J., Park, S., & Li, Q. (2021). Tourism geography through the lens of time use: A computational framework using fine-Grained mobile phone data. *Annals of the American Association of Geographers*, 111(5), 1420–1444.
- Xu, Y., Xue, J., Park, S., & Yue, Y. (2021). Towards a multidimensional view of tourist mobility patterns in cities: A mobile phone data perspective. *Computers, Environment and Urban Systems*, 86, 101593.
- Yao, D., Zhang, C., Huang, J., & Bi, J. (2017). Serm: A recurrent model for next location prediction in semantic trajectories. In *Proceedings of the 2017 ACM on Conference on Information and Knowledge Management* (pp. 2411–2414).
- Zhang, S., & Zhou, W. (2018). Recreational visits to urban parks and factors affecting park visits: Evidence from geotagged social media data. *Landscape and urban planning*, 180, 27–35.
- Zhang, F., Zu, J., Hu, M., Zhu, D., Kang, Y., Gao, S., Zhang, Y., & Huang, Z. (2020). Uncovering inconspicuous places using social media check-ins and street view images. *Computers, Environment and Urban Systems*, 81, 101478.
- Zhao, X., Lu, X., Liu, Y., Lin, J., & An, J. (2018). Tourist movement patterns understanding from the perspective of travel party size using mobile tracking data: A case study of xi'an, China. *Tourism Management*, 69, 368–383.
- Zheng, W., Huang, X., & Li, Y. (2017). Understanding the tourist mobility using gps: Where is the next place? *Tourism Management*, 59, 267–280.
- Zhu, D., Zhang, F., Wang, S., Wang, Y., Cheng, X., Huang, Z., & Liu, Y. (2020). Understanding place characteristics in geographic contexts through graph convolutional neural networks. *Annals of the American Association of Geographers*, 110(2), 408–420.